



CR1s

Parts List & Kits

Contents

Parts List
Spare Part Kits
Accessories
Special Tools
Standard Tools
Tools for Torques

Exploded View CR1s

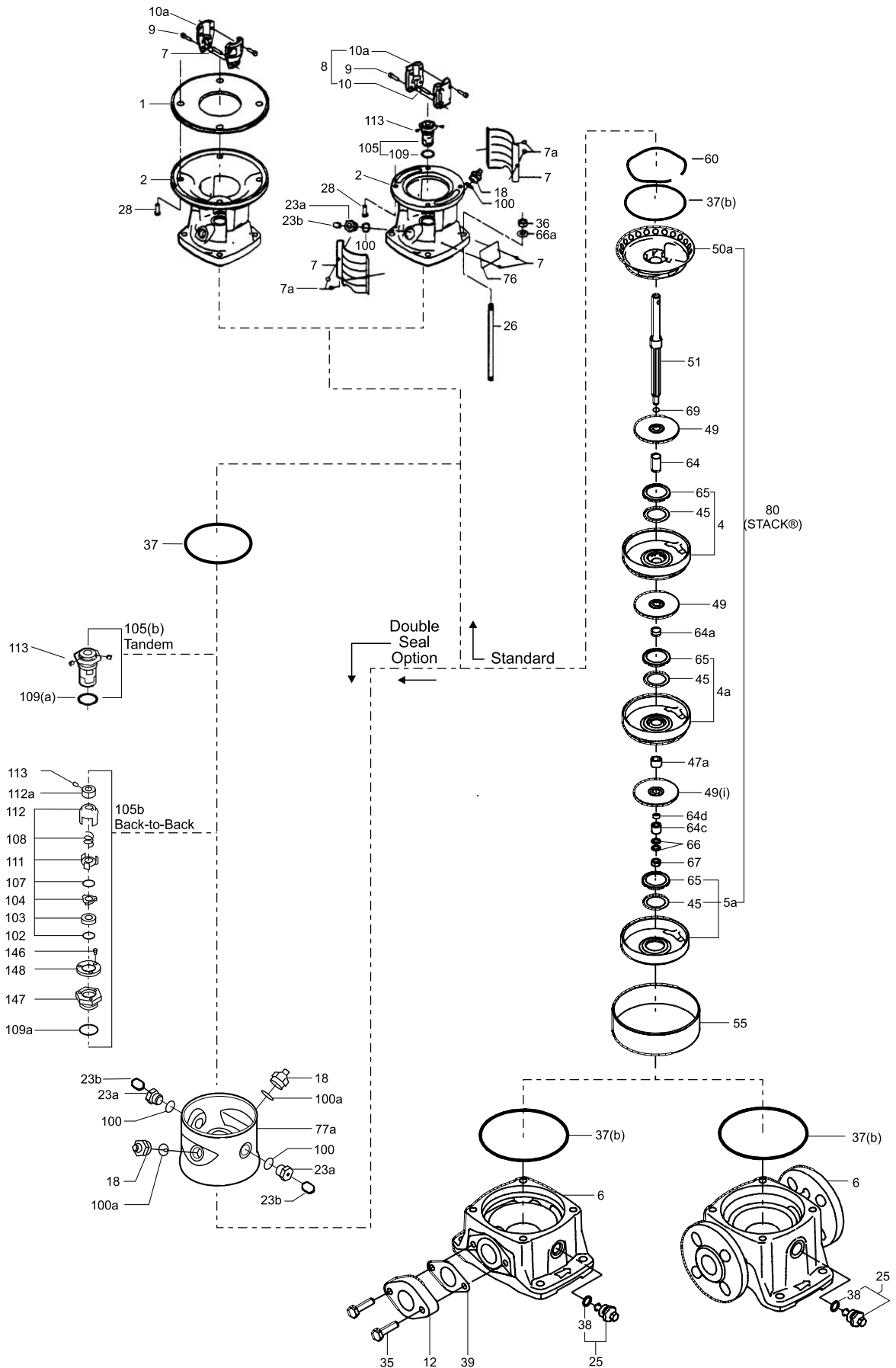

Pos. No.	Part Description	Model	Stages	No. Used	Comments/Dimensions	B.O.M. Ref. No.	Material No.	Included in kits ?
PARTS LIST								
1	Adapter for Motor Stool				For NEMA, 213/215TC, 7.5 - 10HP	96476208		No
2	Motor Stool		3/2-27	1	NEMA, 56C, 1/3 - 2HP	96436501		No
					NEMA, 182/184TC, 3 - 5HP	96436502		No
					Add Pos. 1, NEMA, 213TC, 7.5 - 10HP	96436502		No
			3/2-19 21-36	1	IEC, F85, MG 71, .37 - .55kW	96436495		No
				1	IEC, F100, MG 80, .75 - 1.1kW	96436496		No
				1	IEC, F115, MG 90, 1.5 - 2.2kW	96436499		No
4	Chamber, Complete with Pos. 45 & 65		3/2-36	1	PTFE Pos. 45	96439480	97690020	No
				1	Silicon Carbide Brg, PTFE Pos. 45	96439475	97690601	YES
4a	Chamber Cpl. w/Pos. 45 & 65 & Bearing		3/2-36	1	Bronze Bearing, PTFE Pos. 45	96440612		YES
				1	Graflon Bearing, PTFE Pos. 45	96440615		YES
5a	Chamber, Bottom Complete with Pos. 45 & 65		3/2-36	1	PTFE Pos. 45	96439484	96588148	No
6	Base		3/2-17	1	Oval (max 232 PSI)	96436516		No
				1	JIS, FGJ, ANSI (Max 362 PSI)	96442012		No
7	Coupling Guard			2	IEC, F85-F100	96438136		YES
				2	NEMA-56C, IEC-F115,130, & 265	96438137		YES
				2	NEMA, 182-215TC	96438138		YES
7a	Screw for Coupling Guard		3/2-36	4	M4 x 8mm	96488481		YES
9	Allen Screw		3/2-27	4	M6 x 20mm, Delta Tone/Seal	001D7899		YES
				4	M8 x 25mm, Delta Tone/Seal	001D7900		YES
				4	M10 x 25mm, Delta Tone/Seal	001D7901		YES
10 10a	Shaft Pin Coupling Half		3/2-36	1	ø5 x 26mm	310192		YES
				2	NEMA, 56C, 1/3 - 2HP. ø15.8 / ø12	410108		YES
				2	NEMA, 182/184TC, 3-5HP. ø28.5/ø12	410109		YES
			3/2-19 21-36	2	NEMA, 213TC, 7.5-10HP. ø34.9/ø12	96472175		YES
				2	IEC, F85, MG71, .37-.55kW. ø14/ø12	410041		YES
				2	IEC, F100, MG80,.75-1.1kW. ø19/ø12	410043		YES
12	Oval Flange		3/2-17	2	Painted CI, 1" -11.5 NPT (max 232 PSI)	96468333		YES
				2	Painted CI, RP 1" BSP DIN (max 232 PSI)	400173		No
18	Priming/Vent Plug		3/2-36	*	G 1/2A, NV24 with NV9 x M8 stem	405150	95061351	No
23	Plug (option)		3/2-36	**	G 1/2A, Solid no port, NV24	370025	95061733	No
23a	Plug		3/2-36	**	G 1/2A, w/1/4" port, NV24	91120659		No
23b	Pipe Plug for Pos. 23 & 25 with hollow stem		3/2-36	**	1/4" NPT,SS SQHD	001D7216		No
25	Drain/Priming Plug Cpl. with O-rings		3/2-36	1	G 1/2A, NV24 w/NV9 x M8 stem, EPDM	96440608		No
				1	G 1/2A, NV24 w/NV9 x M8 stem, FKM	96440609		No
				1	G 1/2A, NV24 w/NV9 x M8 stem, FFKM	96486530		No
				1	G 1/2A, NV24 w/NV9 x M8 hollow stem, EPDM	96527046		No
				1	G 1/2A, NV24 w/NV9 x M8 hollow stem, FKM	96527047		No
				1	G 1/2A, NV24 w/NV9 x M8 hollow stem, FFKM	96527049		No
26	Staybolt		3/2-3	4	M12 x 79mm	404002		No
				4	M12 x 97mm	414002		No
				4	M12 x 115mm	404004		No
				4	M12 x 133mm	404005		No
				4	M12 x 151mm	414004		No
				4	M12 x 169mm	404007		No
				4	M12 x 187mm	404008		No
				4	M12 x 205mm	414006		No
				4	M12 x 223mm	404010		No
				4	M12 x 241mm	404011		No
				4	M12 x 259mm	414008		No
				4	M12 x 294mm	96442754		No
				4	M12 x 330mm	96442760		No
				4	M12 x 367mm	414012		No
				4	M12 x 402mm	96442762		No
				4	M12 x 439mm	404022		No
				4	M12 x 475mm	414016		No
				4	M12 x 511mm	404026		No
				4	M12 x 562mm (50 Hz.)	96442766		No
				4	M12 x 618mm (50 Hz.)	96442767		No
4	M12 x 670mm (50 Hz.)	96442768		No				
Staybolt (Back-to-Back & Tandem Seal option)			3/2-3	4	M12 x 187mm	404008		No
				4	M12 x 205mm	414006		No
				4	M12 x 223mm	404010		No
				4	M12 x 241mm	404011		No
				4	M12 x 259mm	414008		No
				4	M12 x 277mm	404013		No
				4	M12 x 294mm	96442754		No

Due to part changes over time, all position numbers (1-203) may not be used.

These columns indicates which model uses the spare part. If blank, the part is used in all models.

B.O.M. Ref Number is only available if it is not included in a kit or does not have a material number listed. If it is included in a kit (YES), or has a material number, request one of these numbers. If not included in a kit (No), but has a Material Number, use Material Number.

Parts List & Kits CR1s

Pos. No.	Part Description	Model	Stages	No. Used	Comments/Dimensions	B.O.M. Ref. No.	Material No.	Included in kits ?
PARTS LIST								
26	Staybolt (Back-to-Back & Tandem Seal option) (continued)		10	4	M12 x 313mm	414010		No
			11	4	M12 x 330mm	96442760		No
			12	4	M12 x 340mm	414011		No
			13	4	M12 x 367mm	414012		No
			15	4	M12 x 402mm	96442762		No
			17	4	M12 x 436mm	96458181		No
			19	4	M12 x 475mm	414016		No
			21	4	M12 x 511mm	404026		No
			23	4	M12 x 546mm	96442765		No
			25	4	M12 x 583mm	404030		No
			27	4	M12 x 618mm	96442767		No
			30	4	M12 x 670mm (50Hz.)	96442768		No
		28	Motor Bolt		3/2-27	4	NEMA, 56C, 1/3 - 2HP. UNC 3/8" x 25mm	001D1839
					NEMA, 182/184TC, 3 - 5HP.UNC1/2" x 25mm	001D1840		No
					NEMA, 213TC, 7.5 -10HP. UNC 1/2" x 1.25"	91128631		No
	3/2-19			4	IEC, F85, MG71, .37-.55kW. M6 x 20mm	001D8022		No
	21-36			4	IEC, F100, MG80,.75-1.1kW. M6 x 25mm	001D8023		No
					IEC, F115, MG 90, 1.5-2.2kW. M8 x 20mm	001D8024		No
					IEC, F130, MG100/112, 3-4 kW. M8 x 25mm	001D8025		No
					IEC, F265, MG132, 5.5-7.5kW. M12 x 45mm	001D7914		No
	3/2-17			4	M10 x 40mm, Delta Seal	001D8027		YES
	3/2-36			4	19mm x M12, Delta Seal	001D7917		No
	3/2-36			◆◆	EPDM, ø137.5 x 3.3mm	96438743		YES
	3/2-36			◆◆	FKM, ø137.5 x 3.3mm	96438744		YES
37b	Sleeve O-ring (option)				3/2-36	◆◆	FXM, ø137.5 x 3.3mm	96458109
			3/2-36	◆◆	FFKM, ø136.12 x 3.53mm	96466718		YES
38	Drain Plug O-ring		3/2-36	1	EPDM, ø16.3 x 2.4mm	001D1288		YES
			3/2-36	1	FKM, ø16.3 x 2.4mm	001D2231		YES
			3/2-36	1	FFKM, ø16.3 x 2.4mm	96428162		YES
			3/2-36	1	FXM, ø16.3 x 2.4mm	96442869		YES
39	Gasket for Oval Flange		3/2-17	2	95 x 55 x ø35 x 2mm, KLINGERSIL C4430	400189		YES
45	Neck Ring		3/2-36	# stgs	ø41.3 x ø30.6 x .75mm, PTFE	400003		YES
47a	Bearing Ring/Spacer Brg. Ring/Spacer (option for Grafion / Brz. 4a)		3/2-36	^^^^	SiC 150, ø17.37 x ø13.10 x ø10.9 x 13mm	96437488		YES
			3/2-36	^^^^	TC, ø15.92 x ø13.10 x ø10.9 x 9.7mm	400041		YES
49	Impeller		3/2-36	# stgs	ø73.0 x ø30.6 x 9.0mm (back-plate .5mm)	96433134		No
50a	Top Guide Vane Top Guide Vane Plate (option for destaging)		3-36	1		96457637		No
			3/2	1		96478562		No
51	Shaft, Complete		3/2-3	1	ø12 x 160.5mm	96439607	96588198	No
			4	1	ø12 x 180.5mm	96440386	96588199	No
			5	1	ø12 x 196.5mm	96440387	96588230	No
			6	1	ø12 x 214.5mm	96440388		No
			7	1	ø12 x 234.5mm	96440389	96588231	No
			8	1	ø12 x 250.5mm	96440390		No
			9	1	ø12 x 268.5mm	96440391		No
			10	1	ø12 x 288.5mm	96440392		No
			11	1	ø12 x 304.5mm	96440393		No
			12	1	ø12 x 322.5mm	96440394	96588233	No
			13	1	ø12 x 342.5mm	96440395	96588234	No
			15	1	ø12 x 376.5mm	96440396	96588235	No
			17	1	ø12 x 412.5mm	96440398		No
			19	1	ø12 x 450.5mm	96440400		No
			21	1	ø12 x 484.5mm	96440401	96588236	No
			23	1	ø12 x 520.5mm	96440403		No
			25	1	ø12 x 556.5mm	96440405	96588237	No
			27	1	ø12 x 592.5mm	96440406		No
			30	1	ø12 x 646.5mm (50 Hz.)	96440408		No
			33	1	ø12 x 700.5mm (50 Hz.)	96440410		No
	36	1	ø12 x 754.5mm (50 Hz.)	96440411	96588238	No		
51	Shaft, Cpl. (Back-to-Back & Tandem Seal option)		3/2-3	1	ø12 x 265.5mm	96457560		No
			4	1	ø12 x 285.5mm	96457561		No
			5	1	ø12 x 301.5mm	96457562		No
			6	1	ø12 x 319.5mm	96457563		No
			7	1	ø12 x 339.5mm	96457564		No
			8	1	ø12 x 355.5mm	96457565		No
			9	1	ø12 x 373.5mm	96457566		No
			10	1	ø12 x 393.5mm	96457567		No
			11	1	ø12 x 409.5mm	96457568		No
			12	1	ø12 x 427.5mm	96457569		No
			13	1	ø12 x 447.5mm	96457570		No
			15	1	ø12 x 481.5mm	96457571		No

Due to part changes over time, all position numbers (1-203) may not be used.

These columns indicates which model uses the spare part. If blank, the part is used in all models.

B.O.M. Ref. Number is only available if it is not included in a kit or does not have a material number listed. If it is included in a kit (YES), or has a material number, request one of these numbers. If not included in a kit (NO), but has a Material Number, use Material Number.

Pos. No.	Part Description	Model	Stages	No. Used	Comments/Dimensions	B.O.M. Ref. No.	Material No.	Included in kits ?
PARTS LIST								
51	Shaft, Cpl. (Back-to-Back & Tandem Seal option)			17	1	ø12 x 517.5mm	96457573	No
				19	1	ø12 x 555.5mm	96457575	No
				21	1	ø12 x 589.5mm	96457576	No
				23	1	ø12 x 625.5mm	96457578	No
				25	1	ø12 x 661.5mm	96457580	No
				27	1	ø12 x 697.5mm	96457581	No
				30	1	ø12 x 751.5mm (50 Hz.)	96457583	No
				33	1	ø12 x 805.5mm (50 Hz.)	96457585	No
				36	1	ø12 x 859.5mm (50 Hz.)	96457586	No
				55	Outer Sleeve		3/2-3	1
4	1	ø138 x 62.6mm	96440010					No
5	1	ø138 x 80.6mm	96441510					No
6	1	ø138 x 98.6mm	96439999					No
7	1	ø138 x 116.6mm	96441511					No
8	1	ø138 x 134.6mm	96441513					No
9	1	ø138 x 152.6mm	96440000					No
10	1	ø138 x 170.6mm	96441514					No
11	1	ø138 x 188.6mm	96441516					No
12	1	ø138 x 206.6mm	96440001					No
13	1	ø138 x 224.6mm	96441517					No
15	1	ø138 x 260.6mm	96440002					No
17	1	ø138 x 296.6mm	96441520					No
19	1	ø138 x 332.6mm	96441521					No
21	1	ø138 x 368.6mm	96440004					No
23	1	ø138 x 404.6mm	96441524					No
25	1	ø138 x 440.6mm	96441525					No
27	1	ø138 x 476.6mm	96440006					No
30	1	ø138 x 530.6mm (50 Hz.)	96440007					No
33	1	ø138 x 584.6mm (50 Hz.)	96440008					No
36	1	ø138 x 638.6mm (50 Hz.)	96439652	No				
60	Stack Compression Spring		3/2-36	1	ø136 x 3.5mm	96439662	96547664	No
64	Spacing Pipe		2-36	^^^	ø15.85 x ø12.85 x 17.52mm	400035	95061339	No
64a	Spacing Pipe (option for Graflon / Brz. 4a)		3/2-36	^^^^	ø15.85 x ø12.85 x 4.5mm	96440292		YES
64c		Clamp, Splined		3/2-36	1	Use with TC Pos.47a, ø15 x ø12.7 x 7.8mm	400016	
65	Neck Ring Retainer		3/2-36	# stgts	ø43.5 x ø34.0 x 3.6mm	96438746		YES
66	Lock Washer Set for Shaft		3/2-36	1	ø13.5 x ø8.2 x 2.6mm	96417297		YES
66a	Washer for Staybolt		3/2-36	4	DIN 125A, ø24 x ø13 x 2.5mm, Delta Seal	96430377		No
67	Lock Nut for Shaft		3/2-36	1	13mm x M8	001D2061		YES
69	Spacing Pipe		3/2	1	ø15.85 x 12.85 x 18.0mm	400125	95061443	No
76	Nameplate		3/2-36	1	304SS, 60 x 45mm	96439820		No
76a	Rivet for Nameplate		3/2-36	2	304SS, ø3 x 5mm	96022882		No
77a	Pump Head Cover for Back-to-Back, Tandem Seal		3/2-36	1	Cast Stainless	96456293		No
100	Priming/Vent Plug O-ring		3/2-36	■	EPDM, ø16.3 x 2.4mm	001D1288		YES
			3/2-36	■	FKM, ø16.3 x 2.4mm	001D2231		YES
			3/2-36	■	FFKM, ø16.3 x 2.4mm	96428162		YES
100a	Priming/Vent Plug O-ring (option)		3/2-36	■	FXM, ø16.3 x 2.4mm	96442869		YES
			3/2-36	1	EPDM, ø18 x 2.5mm	001D2041		YES
			3/2-36	1	FKM, ø17.86 x 2.62mm	001D2187		YES
102	O-ring for Pos. 105b Back-to-Back		3/2-36	1	FKM, ø17.86 x 2.62mm	96440281		No
			3/2-36	1	FFKM, ø17.86 x 2.62mm	96440281		No
			3/2-36	1	FXM, ø17.86 x 2.62mm	96472584		No
103	Stationary Seal Ring for 105b Back-to-Back		3/2-36	1	TC, 12mm	980190		No
			3/2-36	1	SiC, 12mm	980746		YES
104	Rotating Seal Ring for 105b Back-to-Back		3/2-36	1	TC, 12mm	980163		No
			3/2-36	1	SiC, 12mm	980733		YES
105(b)	Shaft Seal HQBE		3/2-36	***	SiC, Carbon with resin-impregnated, EPDM	96441879		YES
	Shaft Seal HQBV		3/2-36	***	SiC, Carbon with resin-impregnated, FKM	96441880		YES
	Shaft Seal HQBK (option)		3/2-36	***	SiC, Carbon with resin-impregnated, FFKM	96489537		YES
	Shaft Seal HQQE		3/2-36	***	SiC, SiC, EPDM	96441877		YES
	Shaft Seal HQQV		3/2-36	***	SiC, SiC, FKM	96441878		YES
	Shaft Seal HQQF (option)		3/2-36	***	SiC, SiC, FXM	96472620		YES
	Shaft Seal HQQK (option)		3/2-36	***	SiC, SiC, FFKM	96464381		YES
	Shaft Seal HUBE		3/2-36	***	TC, Carbon with resin-impregnated, EPDM	96441873		YES
	Shaft Seal HUBV		3/2-36	***	TC, Carbon with resin-impregnated, FKM	96441874		YES
	Shaft Seal HUBF (option)		3/2-36	***	TC, Carbon with resin-impregnated, FXM	96481464		YES
	Shaft Seal HUBK (option)		3/2-36	***	TC, Carbon with resin-impregnated, FFKM	96481463		YES
	Shaft Seal HUUE		3/2-36	***	TC, TC, EPDM	96441875		YES
	Shaft Seal HUUV		3/2-36	***	TC, TC, FKM	96441876		YES
	Shaft Seal HUUF (option)		3/2-36	***	TC, TC, FXM	96475542		YES
	Shaft Seal HUUK (option)		3/2-36	***	TC, TC, FFKM	96467885		YES

Due to part changes over time, all position numbers (1-203) may not be used.

These columns indicates which model uses the spare part. If blank, the part is used in all models.

B.O.M. Ref Number is only available if it is not included in a kit or does not have a material number listed. If it is included in a kit (YES), or has a material number, request one of these numbers. If not included in a kit (No), but has a Material Number, use Material Number.

Parts List & Kits CR1s

Pos. No.	Part Description	Model	Stages	No. Used	Comments/Dimensions	B.O.M. Ref. No.	Material No.	Included in kits ?
PARTS LIST								
105b	Shaft Seal/inboard for Back-to-Back OQQE		3/2-36	1	SiC, SiC, EPDM	985200		YES
	Shaft Seal/inboard for Back-to-Back OQQV		3/2-36	1	SiC, SiC, FKM	985760		YES
	Shaft Seal/inboard for Back-to-Back OOUUE		3/2-36	1	TC, TC, EPDM	985189	405145	No
	Shaft Seal/inboard for Back-to-Back OOUUV		3/2-36	1	TC, TC, FKM	985190	405145	No
107	O-ring for Pos. 105b Back-to-Back		3/2-36	1	EPDM, ϕ 11.5 x 4.3mm	00ID2040		YES
			3/2-36	1	FKM, ϕ 11.5 x 4.3mm	00ID2186		YES
	O-ring for Pos. 105b Back-to-Back (option)		3/2-36	1	FFKM, ϕ 11.5 x 4.3mm	96440282		No
			3/2-36	1	FXM, ϕ 11.5 x 3.18mm	96472618		No
108	Spring for Pos. 105b Back-to-Back		3/2-36	1	12mm	980195		YES
109(a)	O-ring for Shaft Seal Pos.105		3/2-36	1	EPDM, ϕ 21.3 x 3.0mm	00ID1798		YES
			3/2-36	1	FKM, ϕ 21.2 x 3.0mm	00ID2339		YES
109b	O-ring for Shaft Seal Pos. 105 (option)		3/2-36	1	FXM, ϕ 22 x 2.75mm	96458111		YES
			3/2-36	1	FFKM, ϕ 23.47 x 2.62mm	96464384		YES
111	Seal Driver (small) for Pos. 105b Back-to-Back		3/2-36	1		980192		YES
112	Seal Driver (large) for Pos. 105b Back-to-Back		3/2-36	1		980191		YES
112a	Seal Drv threaded for 112, Pos. 105b Back-to-Back		3/2-36	1		400203		YES
113	Set Screw for 112a, for Pos. 105b Back-to-Back		3/2-36	1	3mm x M5 x 6mm	00ID7392		YES
146	Allen Bolt for 147/148, for Pos. 105b Back-to-Back		3/2-36	1	2.5mm x M3 x 5mm	96462639		YES
147	Stationary Seal Retainer- Pos. 105b Back-to-Back		3/2-36	1	NV36, 316SS	96457354		No
148	Seal Retainer Washer- Pos. 105b Back-to-Back		3/2-36	1	316SS, ϕ 36.0 x ϕ 21.6 x 5.0mm	96457355		No

Due to part changes over time, all position numbers (1-203) may not be used.

These columns indicates which model uses the spare part. If blank, the part is used in all models.

B.O.M. Ref. Number is only available if it is not included in a kit or does not have a material number listed. If it is included in a kit (YES), or has a material number, request one of these numbers. If not included in a kit (No), but has a Material Number, use Material Number.

Notes:

- ^^^ 3/2 to 9 stage= # of Stages less 2
10 to 19 stage= # of stages less 3
21 to 27 stage = # of stages less 4
29 to 36 stage = # of stages less 5
- ^^^^ 3/2 to 9 stage= use 1
10 to 19 stage= use 2
21 to 27 stage = use 3
29 to 36 stage = use 4
- * Standard use 1. Back-to-Back or Tandem pump version use 3
- ** Standard use 1. Back-to-Back or Tandem pump version use 3
- *** 1 used in Hxxx (Standard), 2 used in Pxxx (Tandem) pump version
- ◆◆ Standard use 2. Back-to-Back or Tandem pump version use 3
- Standard use 2. Back-to-Back or Tandem pump version use 6

Key to Symbols

- KITS (YES)** Recommended spare part
- ϕ Diameter
- ANSI** American National Standards Institute
- CPL** Complete Assembly – these parts consist of more than one component
- EPDM** Ethylene Propylene (also known as EPR and EPT) – an elastic substance similar to rubber
- FFKM** Kalrez Elastomer made by DuPont
- FKM** Fluoro Elastomer (generic for Viton)
- FXM** Fluoraz Elastomer made by Greene Tweed
- M** International standard thread size designation (thread diameter in mm)
- mm** Millimeter
- MG** Identifies Grundfos motor type/size
- N** Stainless
- NBR** Buna - N (also known as Nitrile) – an elastic substance similar to rubber
- NEMA** National Electrical Manufacturers Association
- PTFE** Teflon
- SiC** Silicon Carbide
- TC** Tungsten Carbide
- UNC** Unified National Coarse – a standard for threads on bolts

Spare Part Kits

Since certain pump parts can be expected to exhibit wear at the same time as related pump parts, they have been grouped into the following kits for your convenience. The numbers indicate the quantity of the part within each kit. Please order these kits using the kit material number at the top of the columns.

CR(I, N)1S, 1, & 3 SiC Bearing						
WEAR PARTS KIT 2-9						
Kit No. 96455095						
WEAR PARTS KIT 10-19						
Kit No. 96455092						
WEAR PARTS KIT 20-27						
Kit No. 96455093						
WEAR PARTS KIT 28-36						
Kit No. 96455094						
Pos. No.	Description	Material No.	Qty. Included in each Kit			
4a	Chamber N Cpl. w/Pos.45 & 65 & SiC Bearing	96439476	1	2	3	4
39	Gasket for Oval Flange, 95 x 55 x Ø35 x 2mm	400189	2	2	2	2
45	Neck Ring, Ø41.3 x Ø30.6 x .75mm, PTFE	400003	8	17	24	32
47a	Bearing Ring/Spacer, SiC 150, 13mm	96437488	1	2	3	4
64a	Spacing Pipe, Ø15.85 x Ø12.85 x 4.5mm	96440292	1	2	3	4
64c	Clamp, Splined, Ø15 x Ø13.10 x Ø10.9 x 13mm	96439668	1	1	1	1
65	Neck Ring Retainer, N, Ø43.5 x Ø34.0 x 3.6mm	96438746	8	17	24	32
66	Lock Washer Set of 2, Ø13.5 x Ø8.2 x 2.6mm	96417297	1	1	1	1
67	Lock Nut, 13mm x M8	00ID2061	1	1	1	1

CR(I, N)1S, 1, & 3 Graflon Bearing						
WEAR PARTS KIT 2-9						
Kit No. 96460140						
WEAR PARTS KIT 10-19						
Kit No. 96455110						
WEAR PARTS KIT 20-27						
Kit No. 96455111						
WEAR PARTS KIT 28-36						
Kit No. 96455112						
Pos. No.	Description	Material No.	Qty. Included in each Kit			
4a	Chamber N Cpl. w/Pos.45 & 65 & Graflon Bearing	96440615	1	2	3	4
39	Gasket for Oval Flange, 95 x 55 x Ø35 x 2mm	400189	2	2	2	2
45	Neck Ring, Ø41.3 x Ø30.6 x .75mm, PTFE	400003	8	17	24	32
47a	Bearing Ring/Spacer, TC, 9.7mm	400041	1	2	3	4
64a	Spacing Pipe, Ø15.85 x Ø12.85 x 7.8mm	400016	1	2	3	4
64c	Clamp, Splined, Ø15 x Ø13.10 x Ø10.9 x 13mm	96439668	1	1	1	1
65	Neck Ring Retainer, N, Ø43.5 x Ø34.0 x 3.6mm	96438746	8	17	24	32
66	Lock Washer Set of 2, Ø13.5 x Ø8.2 x 2.6mm	96417297	1	1	1	1
67	Lock Nut, 13mm x M8	00ID2061	1	1	1	1

CR(I)1S, 1, & 3 Bronze Bearing						
WEAR PARTS KIT 2-9						
Kit No. 96455102						
WEAR PARTS KIT 10-19						
Kit No. 96455104						
WEAR PARTS KIT 20-27						
Kit No. 96455105						
WEAR PARTS KIT 28-36						
Kit No. 96455106						
Pos. No.	Description	Material No.	Qty. Included in each Kit			
4a	Chamber Cpl. w/Pos.45 & 65 & Bronze Bearing	96440612	1	2	3	4
39	Gasket for Oval Flange, 95 x 55 x Ø35 x 2mm	400189	2	2	2	2
45	Neck Ring, Ø41.3 x Ø30.6 x .75mm, PTFE	400003	8	17	24	32
47a	Bearing Ring/Spacer, TC, 9.7mm	400041	1	2	3	4
64a	Spacing Pipe, Ø15.85 x Ø12.85 x 7.8mm	400016	1	2	3	4
64c	Clamp, Splined, Ø15 x Ø13.10 x Ø10.9 x 13mm	96439668	1	1	1	1
65	Neck Ring Retainer, N, Ø43.5 x Ø34.0 x 3.6mm	96438746	8	17	24	32
66	Lock Washer Set of 2, Ø13.5 x Ø8.2 x 2.6mm	96417297	1	1	1	1
67	Lock Nut, 13mm x M8	00ID2061	1	1	1	1

GASKET KIT (EPDM)						
Kit No. 96455090						
GASKET KIT (FKM)						
Kit No. 96455091						
GASKET KIT (FXM)						
Kit No. 96463944						
GASKET KIT (FFKM)						
Kit No. 96533328						
GASKET KIT (EPDM)-Double Seal option.						
Kit No. 96533362						
GASKET KIT (FKM)-Double Seal option.						
Kit No. 96533363						
GASKET KIT (FFKM)-Double Seal option.						
Kit No. 96533364						
Pos. No.	Description	Material No.	Qty. Included in each Kit			
37	Sleeve O-ring, EPDM, Ø137.5 x 3.3mm, EPDM	96438743	2			3
	Sleeve O-ring, FKM, Ø137.5 x 3.3mm, FKM	96438744		2		3
37b	Sleeve O-ring, FXM, Ø137.5 x 3.3mm	96458109			2	
	Sleeve O-ring, FFKM, Ø136.12 x 3.53mm	96466718				3
38, 100(a)	Drain Plug O-ring, EPDM, Ø16.3 x 2.4mm, EPDM	00ID1288	3			7
	Drain Plug O-ring, FKM, Ø16.3 x 2.4mm, FKM	00ID2231		3		7
38, 100a	Drain Plug O-ring, FXM, Ø16.3 x 2.4mm	96442869			3	
	Drain Plug O-ring, FFKM, Ø16.3 x 2.4mm	96428162				7
109(a)	O-ring for Pos.105(b) &149, EPDM, Ø21.3 x 3.0mm	00ID1798	1			1
	O-ring for Pos.105(b) &149, FKM, Ø21.2 x 3.0mm	00ID2339		1		1
109b	O-ring for Pos.105(b) &149, FXM, Ø22.0 x 2.75mm	96458111			1	
	O-ring for Pos.105(b) &149, FFKM, Ø23.47 x 2.62mm	96464384				2

STACK KITS	
Model	Material No.
CR(I)1S-3/2	96479046
CR(I)1S-3	96479047
CR(I)1S-4	96479048
CR(I)1S-5	96479049
CR(I)1S-6	96479060
CR(I)1S-7	96479061
CR(I)1S-8	96479062
CR(I)1S-9	96479063
CR(I)1S-10	96479064
CR(I)1S-11	96479065
CR(I)1S-12	96479066
CR(I)1S-13	96479067
CR(I)1S-15	96479068
CR(I)1S-17	96479069
CR(I)1S-19	96479070
CR(I)1S-21	96479071
CR(I)1S-23	96479072
CR(I)1S-25	96479073
CR(I)1S-27	96479074
*** CR(I)1S-30	96479075
*** CR(I)1S-33	96479076
*** CR(I)1S-36	96479077

***For 50 Hz operation only.

Spare Part Kits (continued)

STANDARD SHAFT SEAL KIT, BALANCED CARTRIDGE (Maximum allowed working PSI is 435) (Tandem Seal option Pumps require 2 of each Seal Kit)		Kit No.	96455088	96455089	96455086	96455087	96455082	96455083	96455084	96455085
Pos. No.	Description	Material No.	Qty. Included in each Kit							
105	HQBE	96441879	1							
	HQBV	96441880		1						
	HQQE	96441877			1					
	HQQV	96441878				1				
	HUBE	96441873					1			
	HUBV	96441874						1		
	HUUE	96441875							1	
	HUUUV	96441876								1
N/A	Grinding Device Tool for Emery Cloth	370711	1	1	1	1	1	1	1	1
N/A	Emery Cloth	370712	1	1	1	1	1	1	1	1

OPTIONAL SHAFT SEAL KIT, BALANCED CARTRIDGE (Maximum allowed working PSI is 435) (Tandem Seal option Pumps require 2 of each Seal Kit)		Kit No.	96491375	96533327	96533326	96533323	96533322	96533325	96533324	
Pos. No.	Description	Material No.	Qty. Included in each Kit							
105	HQBK	96489537	1							
	HQQF	96472620		1						
	HQQK	96498109			1					
	HUBF	96481464				1				
	HUBK	96481463					1			
	HUUF	96475542						1		
	HUUK	96498108							1	
N/A	Grinding Device Tool for Emery Cloth	370711	1	1	1	1	1	1	1	
N/A	Emery Cloth	370712	1	1	1	1	1	1	1	

INBOARD SHAFT SEAL & Gasket KIT, Back to Back OQQE INBOARD SHAFT SEAL & Gasket KIT, Back to Back OQQV (An HQQx seal kit must also be used for a seal repair)		Kit No.	96533360	96533361
Pos. No.	Description	Material No.	Qty. Included in each Kit	
37	Sleeve O-ring, EPDM, ø137.5 x 3.3mm	96438743	3	
	Sleeve O-ring, FKM, ø137.5 x 3.3mm	96438744		3
38, 100(a)	Drain Plug O-ring, EPDM, Ø16.3 x 2.4mm	00ID1288	7	
	Drain Plug O-ring, FKM, Ø16.3 x 2.4mm	00ID2231		7
102	O-ring, EPDM, ø18 x 2.5mm	00ID2041	1	
	O-ring, FKM, ø17.86 x 2.62mm	00ID2187		1
103	Stationary Seal Ring, SiC, 12mm	980746	1	
104	Rotating Seal Ring, SiC, 12mm	980733	1	1
107	O-ring, EPDM, ø11.5 x 4.3mm	00ID2040	1	
	O-ring, FKM, ø11.5 x 4.3mm	00ID2186		1
108	Spring, 12mm	980195	1	1
109a	O-ring, EPDM, ø21.3 x 3.0mm	00ID1798	1	
	O-ring, FKM, ø21.2 x 3.0mm	00ID2339		1
111	Driver for pos.104	980192	1	1
112	Driver for pos.111	980191	1	1
112a	Driver for pos.112	400203	1	1
113	Set Screw for pos.112a	00ID7392	2	2
146	Allen Bolt for pos.147 & 148, 2.5mm x M3 x 5mm	96462639	3	3

IEC COUPLING KIT		Kit No.	415060	415061	415062	415063	415065
Pos. No.	Description	Material No.	Qty. Included in each Kit				
9	Allen Screw, M6 x 20mm, Delta Seal	00ID7899	4				
	Allen Screw, M8 x 25mm, Delta Seal	00ID7900		4	4	4	
	Allen Screw, M10 x 25mm, Delta Seal	00ID7901					4
10	Shaft Pin, ø5 x 26mm, Stainless	310192	1	1	1	1	1
10a	Coupling Half, F85, MG71, .37-.55kW. ø14/ø12	410041	2				
	Coupling Half, F100, MG80, .75-1.1kW. ø19/ø12	410043		2			
	Coupling Half, F115, MG 90, 1.5-2.2kW. ø24/ø12	410045			2		
	Coupling Half, F130, MG100/112, 3-4 kW.ø28/ø12	410047				2	
	Coupling Half, F265, MG132, 5.5-7.5kW. ø38/ø12	410115					2

Spare Part Kits (continued)

NEMA COUPLING KIT				Kit No. 415314	
ø15.8/ø12				Kit No. 415315	
ø28.5/ø12				Kit No. 96478700	
ø34.9/ø12				Kit No. 96478700	
Pos. No.	Description	Material No.	Qty. Included in each Kit		
9	Allen Screw, M6 x 20mm, Delta Seal	00ID7899	4		
	Allen Screw, M8 x 25mm, Delta Seal	00ID7900		4	4
	Allen Screw, M10 x 25mm, Delta Seal	00ID7901			
10	Shaft Pin, ø5 x 26mm, Stainless	310192	1	1	1
10a	Coupling Half, 56C, 1/3 - 2HP, ø15.8 / ø12	410108	2		
	Coupling Half, 182/184TC, 3-5HP, ø28.5/ø12	410109		2	
	Coupling Half, 213TC, 7.5-10HP, ø34.9/ø12	96472175			2

COUPLING GUARD KIT				Kit No. 96505130	
IEC, F85-F100, .37 to 1.1 kW				Kit No. 96505131	
NEMA 56C, 1/3-2HP; IEC-F115-130 & 265, 1.5-4.0 kW				Kit No. 96505132	
NEMA 182-215TC, 3-10HP				Kit No. 96505132	
Pos. No.	Description	Material No.	Qty. Included in each Kit		
7	Coupling Guard, W=127mm x H=66mm	96438136	2		
	Coupling Guard, W=127mm x H=90.5mm	96438137		2	
	Coupling Guard, W=157mm x H=171mm	96438138			2
7a	Screw comb.slot torx/straight slot 4x8mm	96488481	4	4	4

OVAL FLANGE KIT FOR SMALL CR1S, 1, & 3				Kit No. 96474336	
1" Threaded Cast Iron (232 PSI Max.)				Kit No. 96474336	
Pos. No.	Description	Material No.	Qty. Included in each Kit		
12	Flange, Cast Iron, 1" - 11.5 NPT	96468333		2	
35	Hex Head Bolt, M10 x 40mm, Delta Seal	00ID8027		4	
39	Gasket , 95 x 55 x ø35 x 2mm, KLINGERSIL C4430	400189		2	





Accessories

ANSI COMPANION FLANGES FOR SMALL CR				Kit No. 91122260	
1-1/4" Threaded Cast Iron, 250 Lb. Class				Kit No. 91122260	
Pos. No.	Description	Material No.	Qty. Included in each Kit		
N/A	Nut, HEX 5/8"-11 UNC, Grade 2	00ID1510		8	
N/A	Plain Bolt, 5/8" x 2-1/2", Grade 2	00ID1920		8	
N/A	Flange, Cast Iron, 1-1/4"	00ID3650		2	
N/A	Gasket Full Face Flange, 1-1/4", 300#, Cut Ring	400201		2	

Spare Part Kits • Special Tools CR1s

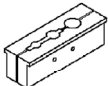
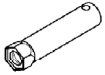
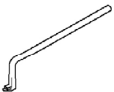

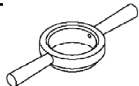
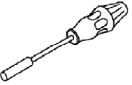
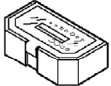

Special Tools

Tools not generally available from normal sources.

Mat. No.	Description and Use	
00SV0040	Shaft Holder for Dismantling/Assembly Used to hold and protect the shaft during dismantling and assembly.	
00SV2007	Tubular Box Spanner for Shaft Seal 36.1 mm Used to install and remove the shaft seal. Fits a 1/2" drive ratchet.	
00SV0239	Puller for Neck Ring Used to remove the Neck Ring from Chamber.	
00SV2014	Circlip Pliers for Flange Lock Ring Used to remove the Lock Ring for the Flange.	
00SV2066	Tool for Outer Sleeve Used to press sleeve into base. (optional)	
00SV2011	Bit Holder Used with Bits Kit, 1/4"	
00SV2010	Bits Kit NV 5 mm for M6, 1/4" NV 6 mm for M8, 1/4" NV 8 mm for M10, 1/4"	
00SV2012	Hexagon Socket Bit Used for Shaft Seal NV 2.5 mm for M5, 1/4"	

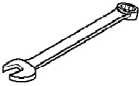
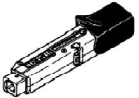
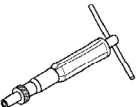
Standard Tools

In addition to being available from Grundfos, comparable tools can be purchased through normal sources.

Mat. No.	Description and Use	
00SV0083 00SV0055 00SV0056 00SV0054 00SV0122	Wrenches Used to tighten various nuts. NV 10 mm for M6 NV 13 mm for M8 NV 17 mm for M10 NV 19 mm for M12 NV 24 mm for M16	
00SV0292 00SV0269 00SV0400	Torque Wrench Used to torque various screws. 4-20 Nm, 9 x 12 20-100 Nm, 9 x 12 40-200 Nm, 14x18	
00SV0438	Torque Screwdriver Used to tighten various nuts. 1-6 Nm, 1/4"	
00SV0295	Ratchet Spanner for all Adapters 9 mm x 12 mm, 1/2"	
00SV0296 00SV0297 00SV0298	Socket Spanner with Inside Hex NV 5 mm for M6, 1/2" x 1/2" NV 6 mm for M8, 1/2" x 1/2" NV 8 mm for M10, 1/2" x 1/2"	
00SV0310 00SV0294 00SV0270 00SV0271 00SV0524	Ring Spanner NV 10 mm for M6 NV 13 mm for M8 NV 17 mm for M10 NV 19 mm for M12 NV 24 mm for M16	
00SV2013	Socket Spanner NV 13 mm for M8, 9 x 12	

L-CR-SM-025 0613

The name Grundfos, the Grundfos logo, and **be think innovate** are registered trademarks owned by Grundfos Holding A/S, Denmark. All rights reserved worldwide. © Copyright Grundfos Holding A/S

GRUNDFOS Pumps Corporation
17100 W. 118th Terrace
Olathe, Kansas 66062
Phone: 913.227.3400
Fax: 913.227.3500

www.grundfos.us

GRUNDFOS Canada, Inc.
2941 Brighton Road
Oakville, Ontario L6H 6C9 Canada
Phone: 905.829.9533
Fax: 905.829.9512

Bombas GRUNDFOS de Mexico S.A. de C.V.
Boulevard TLC No. 15
Parque Industrial Stiva Aeropuerto
Apodaca, N.L. Mexico 66600
Phone: 52.81.8144.4000
Fax: 52.81.8144.4010

GRUNDFOS 